

NPN Silicon AF Transistor

- High breakdown voltage
- Low collector-emitter saturation voltage
- Complementary type: SMBTA56 (PNP)
MMBTA56 (PNP)

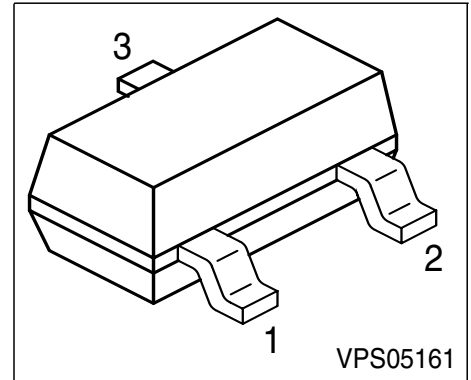

Type	Marking	Pin Configuration			Package
SMBTA06/ MMBTA06	s1G	1=B	2=E	3=C	SOT23

Maximum Ratings

Parameter	Symbol	Value	Unit
Collector-emitter voltage	V_{CEO}	80	V
Collector-base voltage	V_{CBO}	80	
Emitter-base voltage	V_{EBO}	4	
DC collector current	I_C	500	mA
Peak collector current	I_{CM}	1	A
Base current	I_B	100	mA
Peak base current	I_{BM}	200	
Total power dissipation, $T_S = 79\text{ °C}$	P_{tot}	330	mW
Junction temperature	T_j	150	°C
Storage temperature	T_{stg}	-65 ... 150	

Thermal Resistance

Junction - soldering point ¹⁾	R_{thJS}	≤215	K/W
--	------------	------	-----

¹⁾For calculation of R_{thJA} please refer to Application Note Thermal Resistance

Electrical Characteristics

Parameter	Symbol	Values			Unit
		min.	typ.	max.	
DC Characteristics					
Collector-emitter breakdown voltage $I_C = 1 \text{ mA}, I_B = 0$	$V_{(BR)CEO}$	80	-	-	V
Collector-base breakdown voltage $I_C = 100 \text{ }\mu\text{A}, I_E = 0$	$V_{(BR)CBO}$	80	-	-	
Emitter-base breakdown voltage $I_E = 10 \text{ }\mu\text{A}, I_C = 0$	$V_{(BR)EBO}$	4	-	-	
Collector cutoff current $V_{CB} = 80 \text{ V}, I_E = 0$	I_{CBO}	-	-	100	nA
Collector cutoff current $V_{CB} = 80 \text{ V}, I_E = 0, T_A = 150 \text{ }^\circ\text{C}$	I_{CBO}	-	-	20	μA
Collector cutoff current $V_{CE} = 60 \text{ V}, I_B = 0$	I_{CEO}	-	-	100	nA
DC current gain 1) $I_C = 10 \text{ mA}, V_{CE} = 1 \text{ V}$ $I_C = 100 \text{ mA}, V_{CE} = 1 \text{ V}$	h_{FE}	100 100	- -	- -	-
Collector-emitter saturation voltage1) $I_C = 100 \text{ mA}, I_B = 10 \text{ mA}$	V_{CEsat}	-	-	0.25	V
Base-emitter voltage 1) $I_C = 100 \text{ mA}, V_{CE} = 1 \text{ V}$	$V_{BE(ON)}$	-	-	1.2	
AC Characteristics					
Transition frequency $I_C = 20 \text{ mA}, V_{CE} = 5 \text{ V}, f = 20 \text{ MHz}$	f_T	-	100	-	MHz
Collector-base capacitance $V_{CB} = 10 \text{ V}, f = 1 \text{ MHz}$	C_{cb}	-	12	-	pF

 1) Pulse test: $t \leq 300 \mu\text{s}$, $D = 2\%$

Total power dissipation $P_{tot} = f(T_S)$

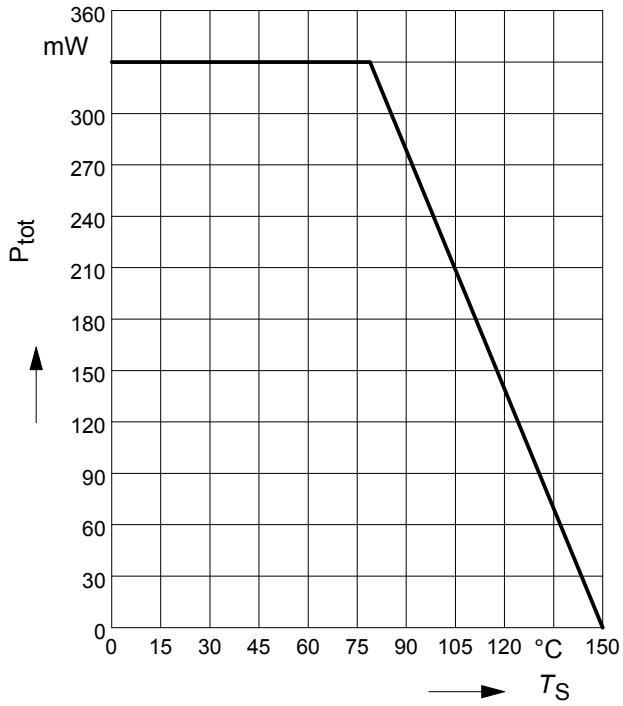

Collector current $I_C = f(V_{BE})$

$V_{CE} = 1V$

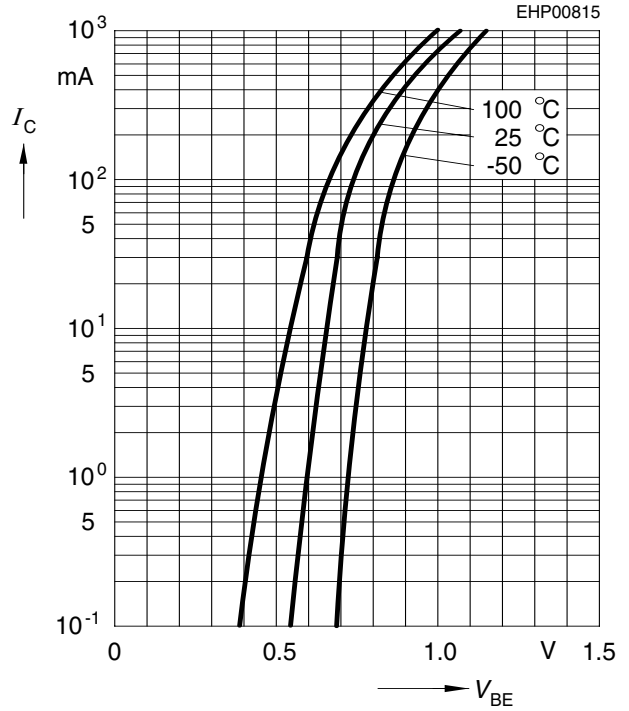

Permissible pulse load

$P_{totmax} / P_{totDC} = f(t_p)$

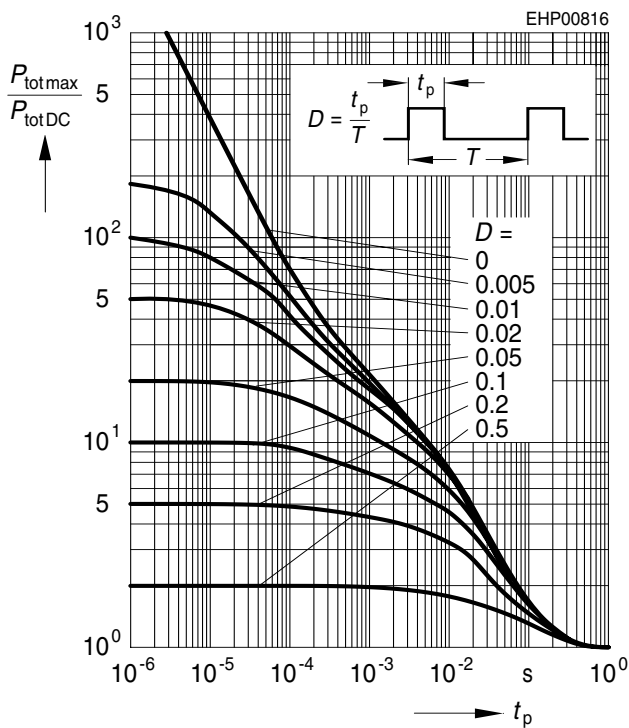

Transition frequency $f_T = f(I_C)$

$V_{CE} = 5V$

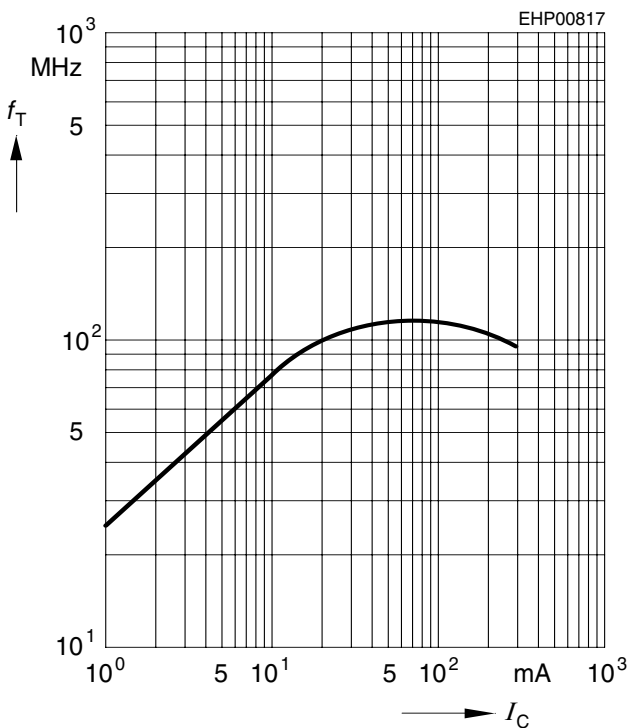

Base-emitter saturation voltage

$I_C = f(V_{BEsat}), h_{FE} = 10$

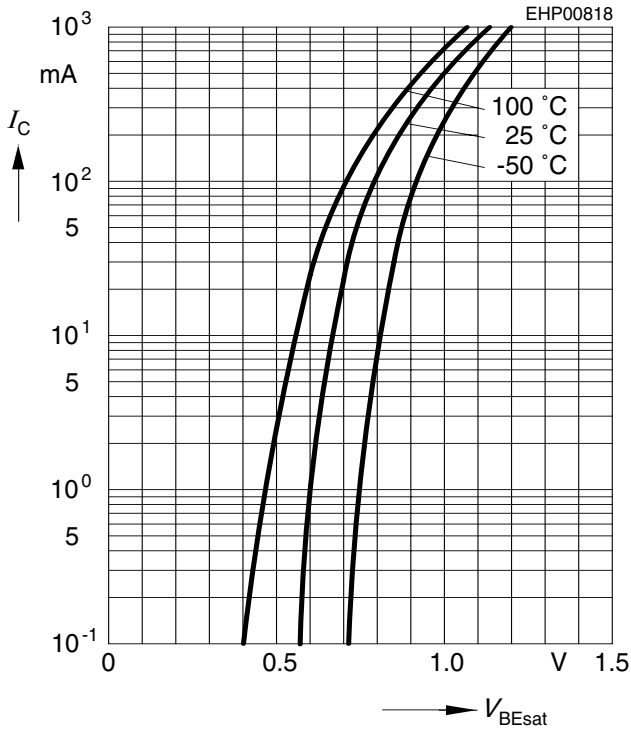

Collector-emitter saturation voltage

$I_C = f(V_{CEsat}), h_{FE} = 10$

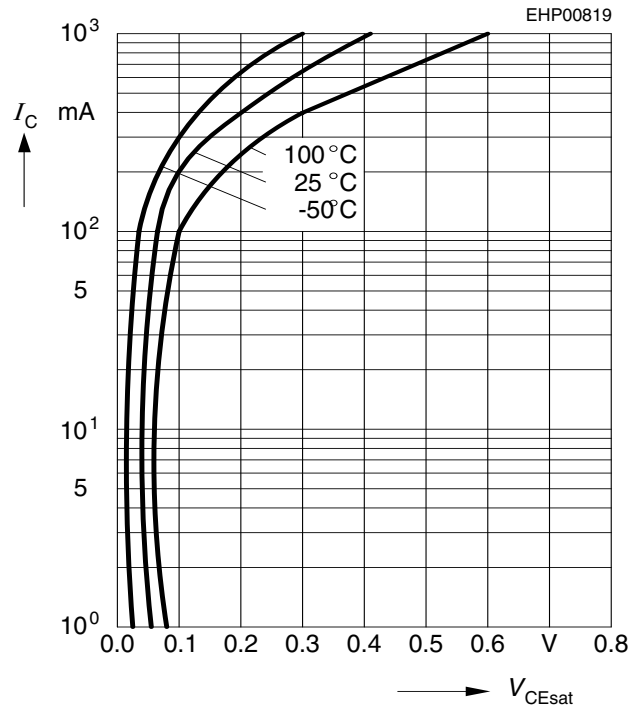

Collector cutoff current $I_{CBO} = f(T_A)$

$V_{CB} = 80V$

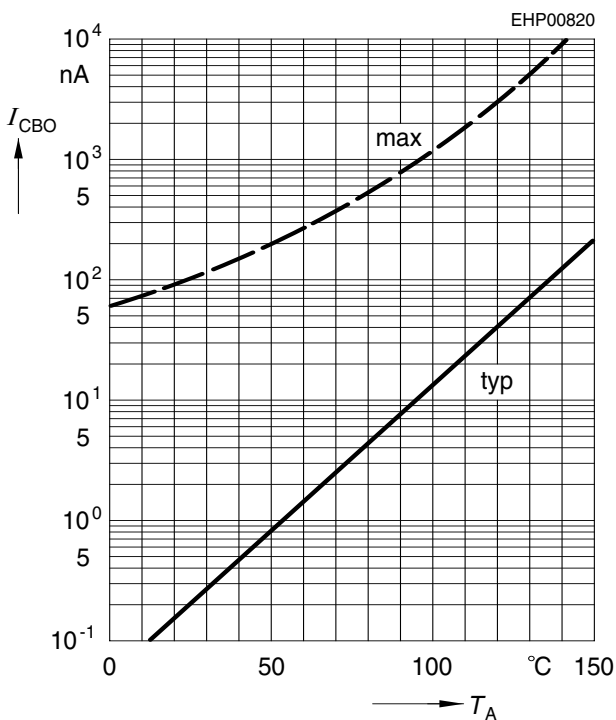

DC current gain $h_{FE} = f(I_C)$

$V_{CE} = 1V$

